

Bau027



Majestätisch erheben.

Duschtürbänder mit Hebe- und Senkmechanismus



Hebe- und Senkbänder sind besonders für Installationen ohne Duschtasse geeignet. Die Beschläge heben die Tür beim Öffnen um ca. 5 Millimeter an. Die unteren Dichtungen werden geschont, da sie in der Bewegung der Tür keinen Bodenkontakt haben. Die Schwerkraft sorgt für eine automatische Schließbewegung der Tür ab einem Öffnungswinkel von ca. 45°. Im geschlossenen Zustand versiegeln die Dichtungen die Tür wieder sicher auf dem Boden.

BARRIEREFREI

Bemerkung:

Beschläge DIN R und DIN L verfügbar. Tür wird beim öffnen um ca. 5 mm angehoben.

Abbildung zeigt BH 200



**Hebe- & Senk-
Beschläge**

frINFO - Hebe- und Senkbeschläge

Metall

Duschtürband BH 200

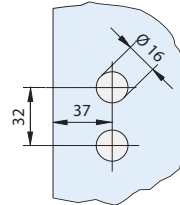
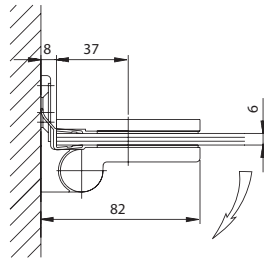
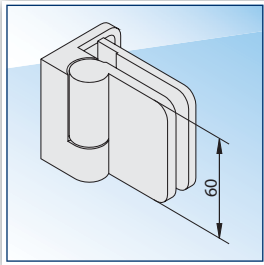

Art.-Nr	Bezeichnung
70.283	Glas-Wand, rechts
70.284	Glas-Wand, links

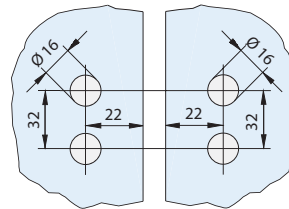
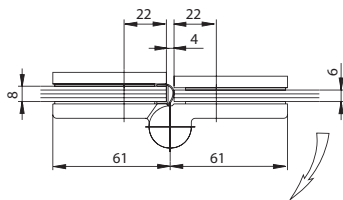
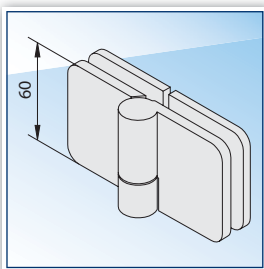

Art.-Nr	Bezeichnung
70.285	Glas-Glas 180°, rechts
70.286	Glas-Glas 180°, links

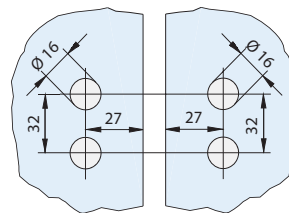
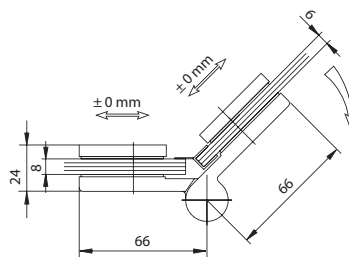
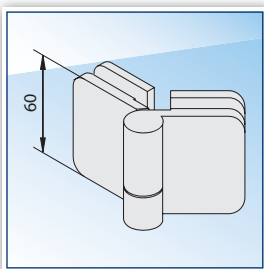

Art.-Nr	Bezeichnung
70.287	Glas-Glas 135°, rechts
70.288	Glas-Glas 135°, links

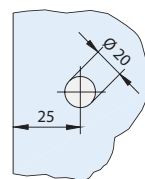
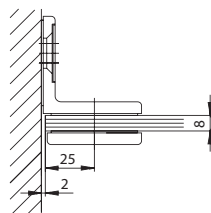
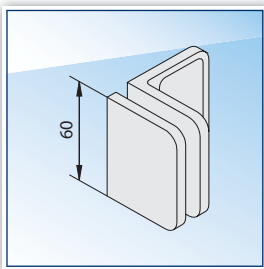

Art.-Nr	Bezeichnung
01.2100	Winkel Glas-Wand

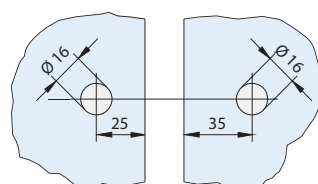
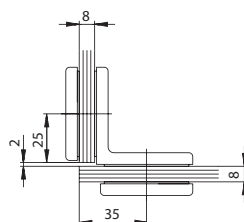
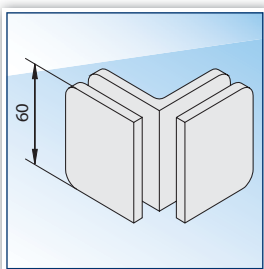

Art.-Nr	Bezeichnung
01.2460	Winkel Glas-Glas 90°



Duschtürband BH 205 - flächenbündig

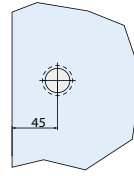
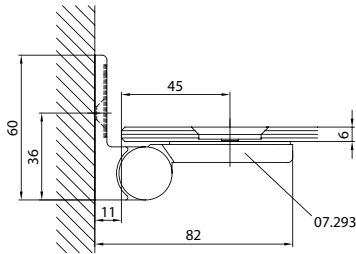
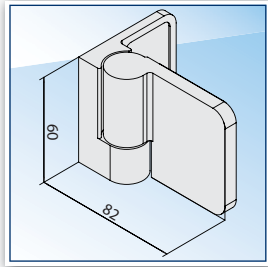

Art.-Nr	Bezeichnung
70.292	Glas-Wand, rechts
70.293	Glas-Wand, links

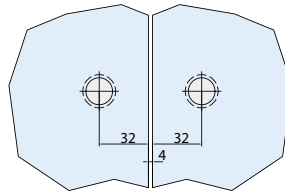
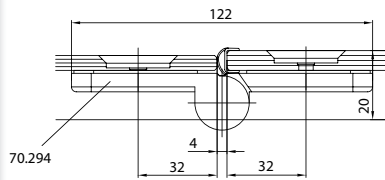
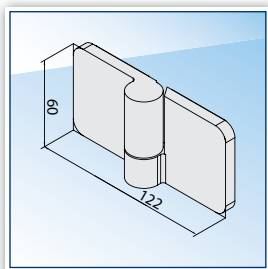

Art.-Nr	Bezeichnung
70.294	Glas-Glas 180°, rechts
70.295	Glas-Glas 180°, links

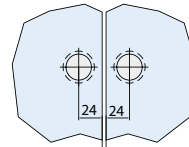
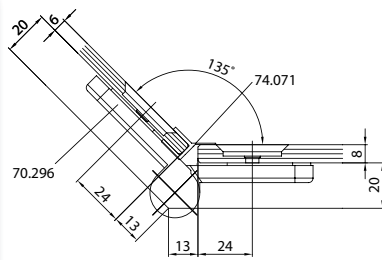
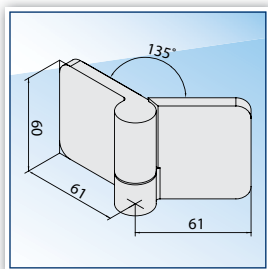

Art.-Nr	Bezeichnung
70.296	Glas-Glas 135°, rechts
70.297	Glas-Glas 135°, links

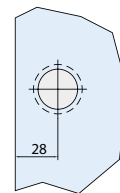
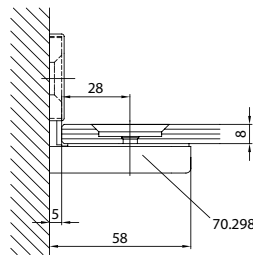
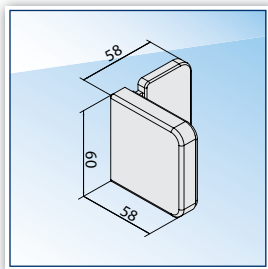

Art.-Nr	Bezeichnung
70.298	Winkel Glas-Wand

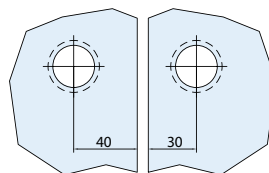
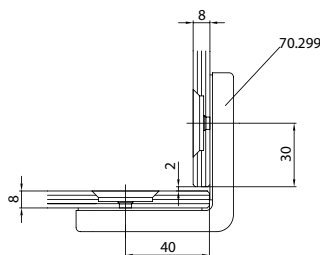
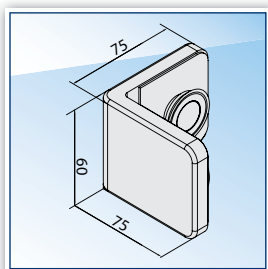

Art.-Nr	Bezeichnung
70.299	Winkel Glas-Glas 90°



fri*line* Hebe- und Senkbeschläge

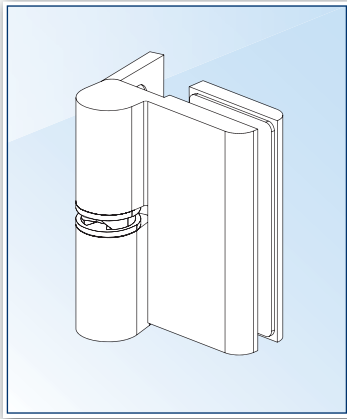

Duschtürband Glas-Wand

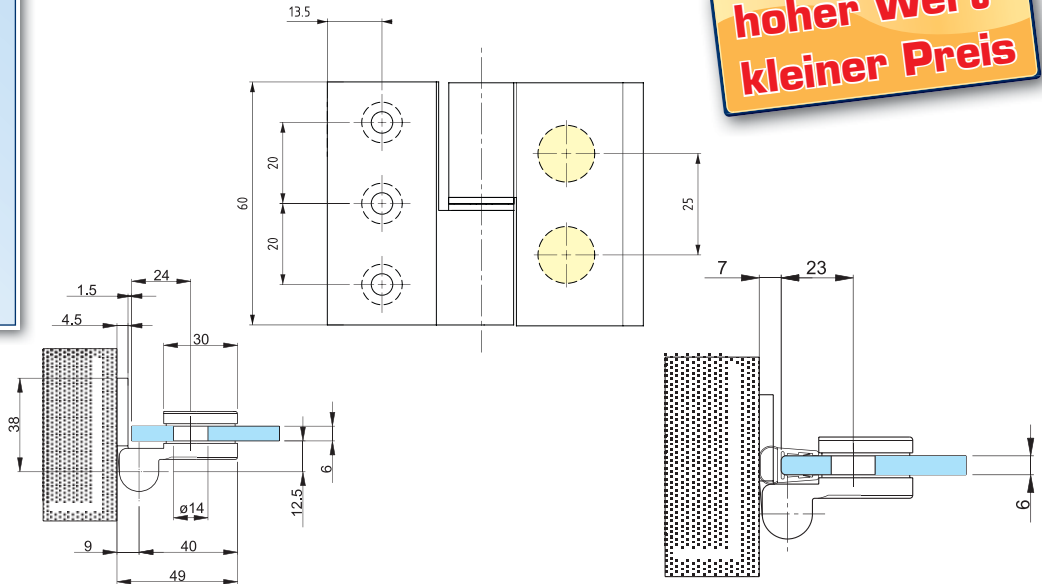

Art.-Nr	Bezeichnung	Glasdicken	Türflügelbreite	Türflügelgewicht
8410-1	Glas-Wand, rechts	6, 8, 10 mm	800 mm	44 kg
8410-2	Glas-Wand, links	6, 8, 10 mm	800 mm	44 kg

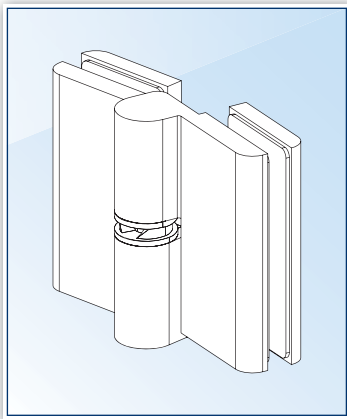

Duschtürband Glas-Glas

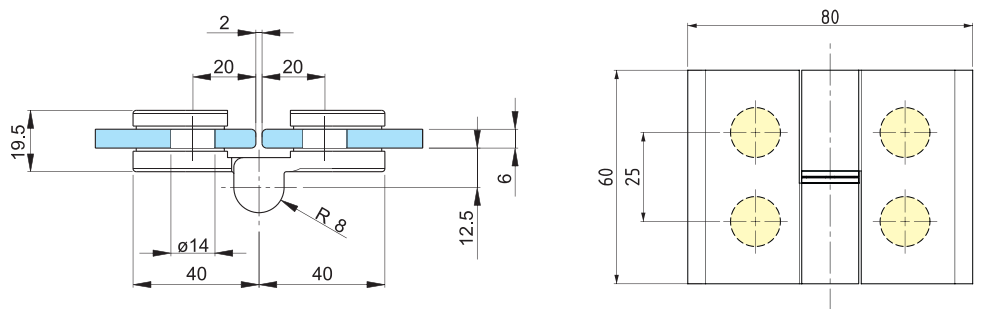

Art.-Nr	Bezeichnung	Glasdicken	Türflügelbreite	Türflügelgewicht
84111	Glas-Glas, rechts	6, 8, 10 mm	800 mm	40 kg
84112	Glas-Glas, links	6, 8, 10 mm	800 mm	40 kg

Julius Fritsche GmbH • Glas-Metall-Kunststoff • Großhandel • office@fritsche.eu.com • www.fritsche.eu.com

Firmensitz Salzburg • Glas Plainstraße 100 • A-5020 Salzburg Tel. +43 6223 3212 - 100 • Fax -999	Standort Anthering • Metall Landstraße 22 • A-5102 Anthering Tel. +43 6223 3212 - 600 • Fax -997	Standort Anthering • Kunststoff Landstraße 26 • A-5102 Anthering Tel. +43 6223 3212 - 300 • Fax -998	Standort Anthering • Service Landstraße 24 • A-5102 Anthering Tel. +43 6223 3212 - 800 • Fax -899
Glas	Metall	Kunststoff	Service